

Thank you for choosing our product

Pyle Audio
1 600 63rd st , Brooklyn, NY, 11204
(718)236-8000

Warning

This product contains small items that could be a choking hazard if swallowed. Keep these items away from young children!

1. Make sure these instructions are read and completely understood before attempting installation. If you are unsure of any part of this installation, contact a professional installer for assistance.
2. The wall or mounting surface must be capable of supporting the combined weight of the mount and the display; otherwise the structure must be reinforced.
3. Safety gear and proper tools must be used. A minimum of two people are required for this installation. Failure to use safety gear can result in property damage, serious injury or death.



INSTALLATION GUIDE

Item No.:PSWLE54

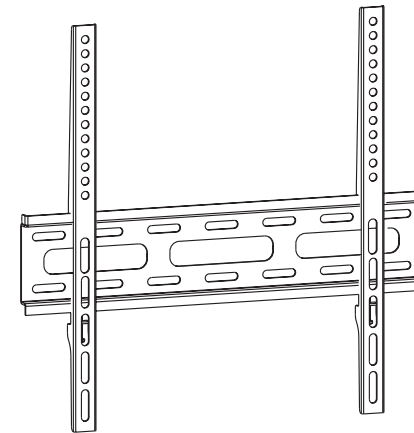

- TV Size Range: 23" ~ 46"
- Maximum Weight Capacity: 30kg/66lbs
- Locked by safety bolt on the bottom
- Balance adjust system is included

www.pyleaudio.com

CAUTION

This product was designed to be installed on wood stud walls and solid concrete walls. Before installing make sure the supporting surface will support the combined load of the equipment and hardware. Never exceed the Maximum Load Capacity. This product is intended for indoor use only. Use of this product outdoors could lead to product failure or personal injury.

Hardware Kit:

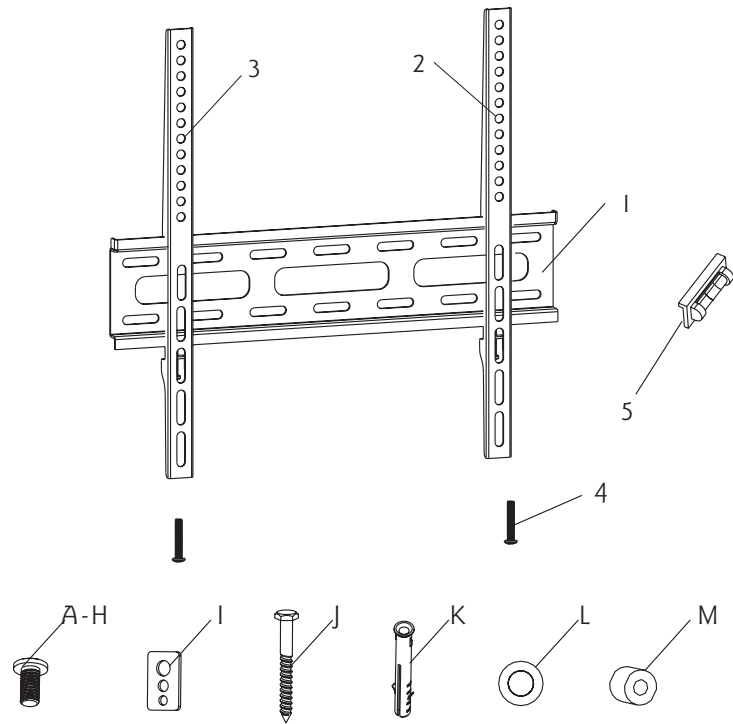

ID	Qty	Description
1	1	Wall plate
2	1	Left bracket
3	1	Right bracket
4	2	Safety bolt
5	1	Bubble level
A	4	M4×12mm bolt
B	4	M4×16mm bolt
C	4	M5×16mm bolt
D	4	M6×16mm bolt
E	4	M8×16mm bolt

ID	Qty	Description
F	4	M5×36mm bolt
G	4	M6×36mm bolt
H	4	M8×36mm bolt
I	4	Square washer
J	6	Long bolt
K	6	Wall anchor
L	6	Long bolt washer
M	4	Spacer

Part 3-Mounting the flat panel screen

Hook the top of brackets(2,3) onto the top flange of wall plate(1). Then swing the screen down. Tighten the safety screw(4) on each bracket to lock the screen into place.

NOTE: Always use an assistant or mechanical lifting equipment to safely lift and position heavy equipment.

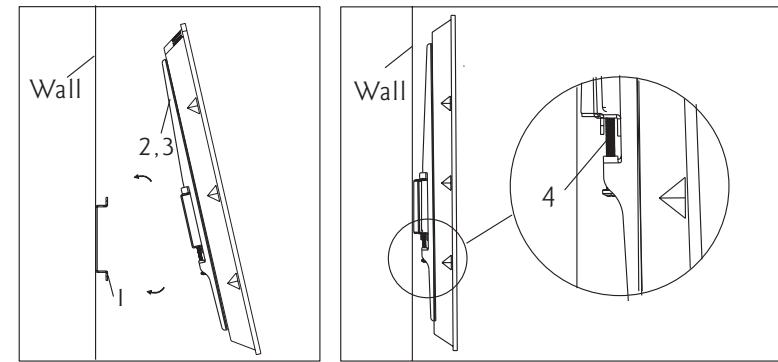

Part 2b-Attaching brackets to screen with recessed back

Center brackets vertically on back of screen. Select the medium(F or G) or large(H) screws. Attach brackets to screen using four selected screws, four square washers(I) and four spacers(M) at the top and bottom of each bracket. Tighten screws firmly. Do not overtighten.

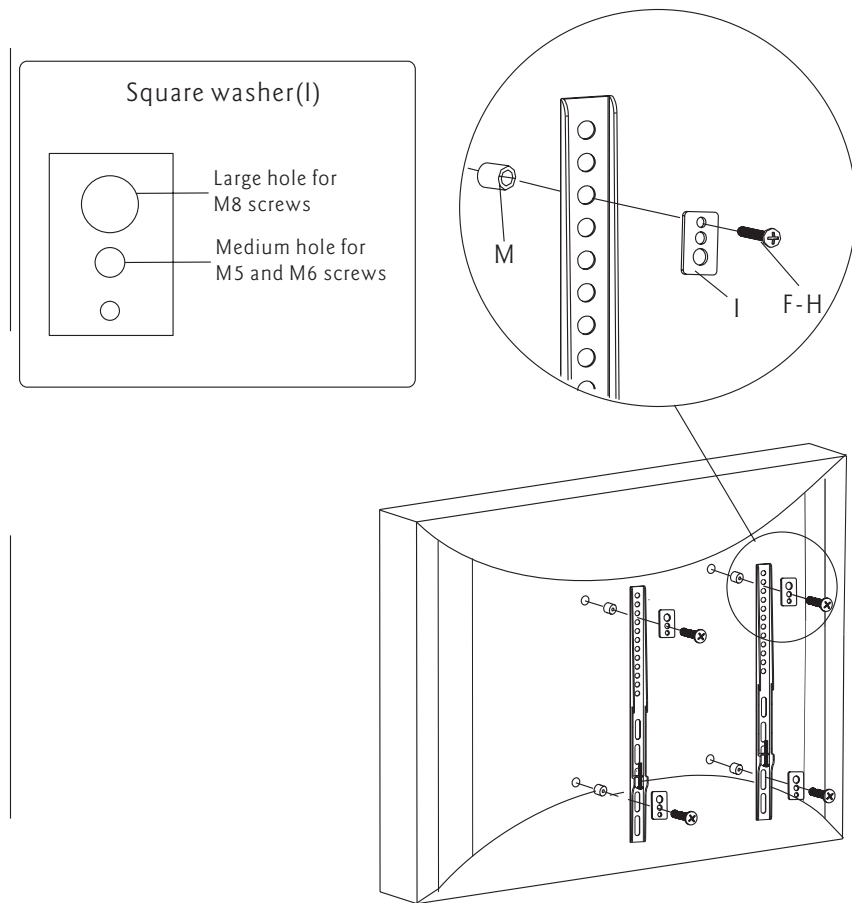

Part 1a-Wood Stud Mounting

Use wall plate as a template, make sure it is level, and mark mounting holes along the center lines of the wood studs. Drill 3/16" (5mm) dia. holes 2" (50mm) deep. Level wall plate and attach to wall with long bolts(J) and washers(L). Tighten screws firmly. Do not overtighten.

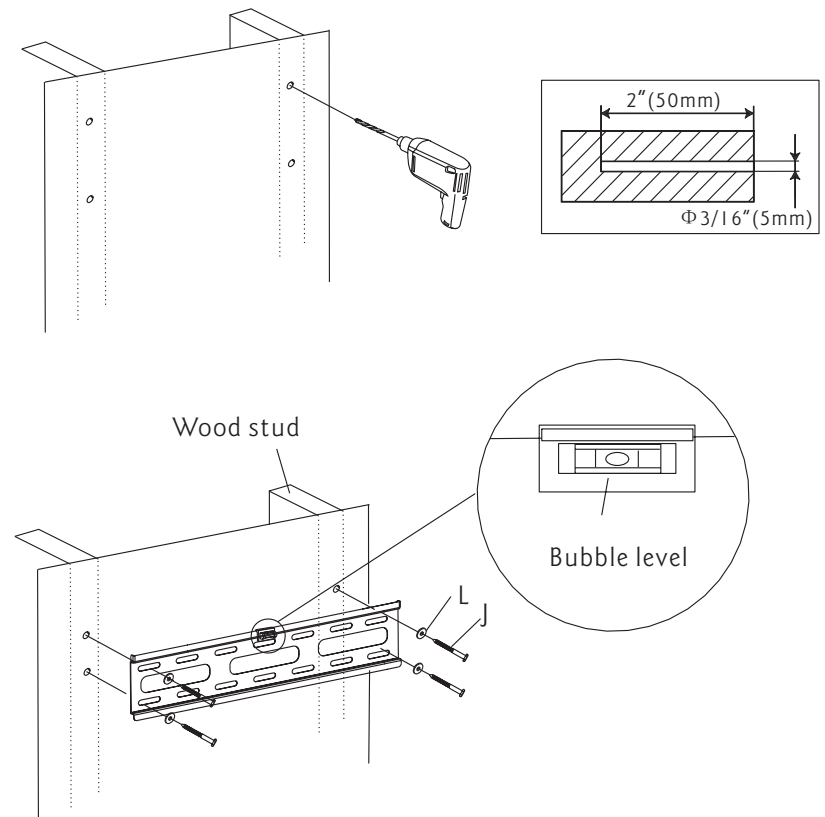

Part 1b-Concrete Wall Mounting

Level wall plate and use it as a template to mark holes. Drill 3/8" (10mm) dia. holes 2" (50mm) deep. Insert anchors(K) into holes and secure wall plate with long bolts(J) and washers(L). Tighten screws firmly. Do not overtighten.

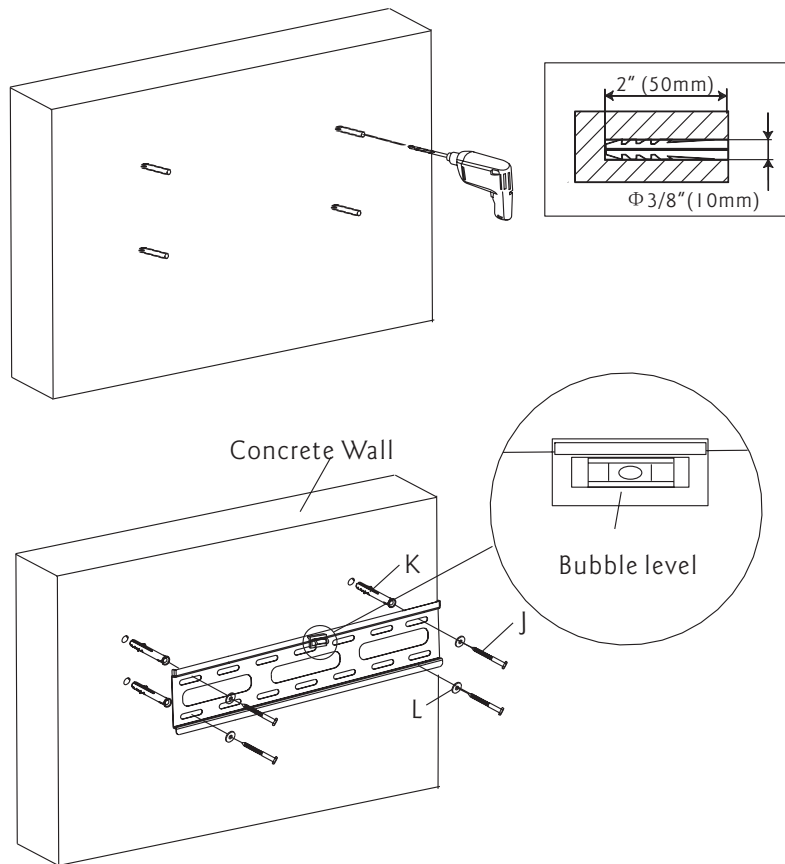

Part 2a-Attaching Brackets To Screen With Flat Back

Center brackets vertically on back of screen. Select the small(A or B), medium (C or D) or large(E) screws. Attach brackets to screen using four selected screws and four square washers(I) at the top and bottom of each bracket. Tighten screws firmly. Do not overtighten.

